

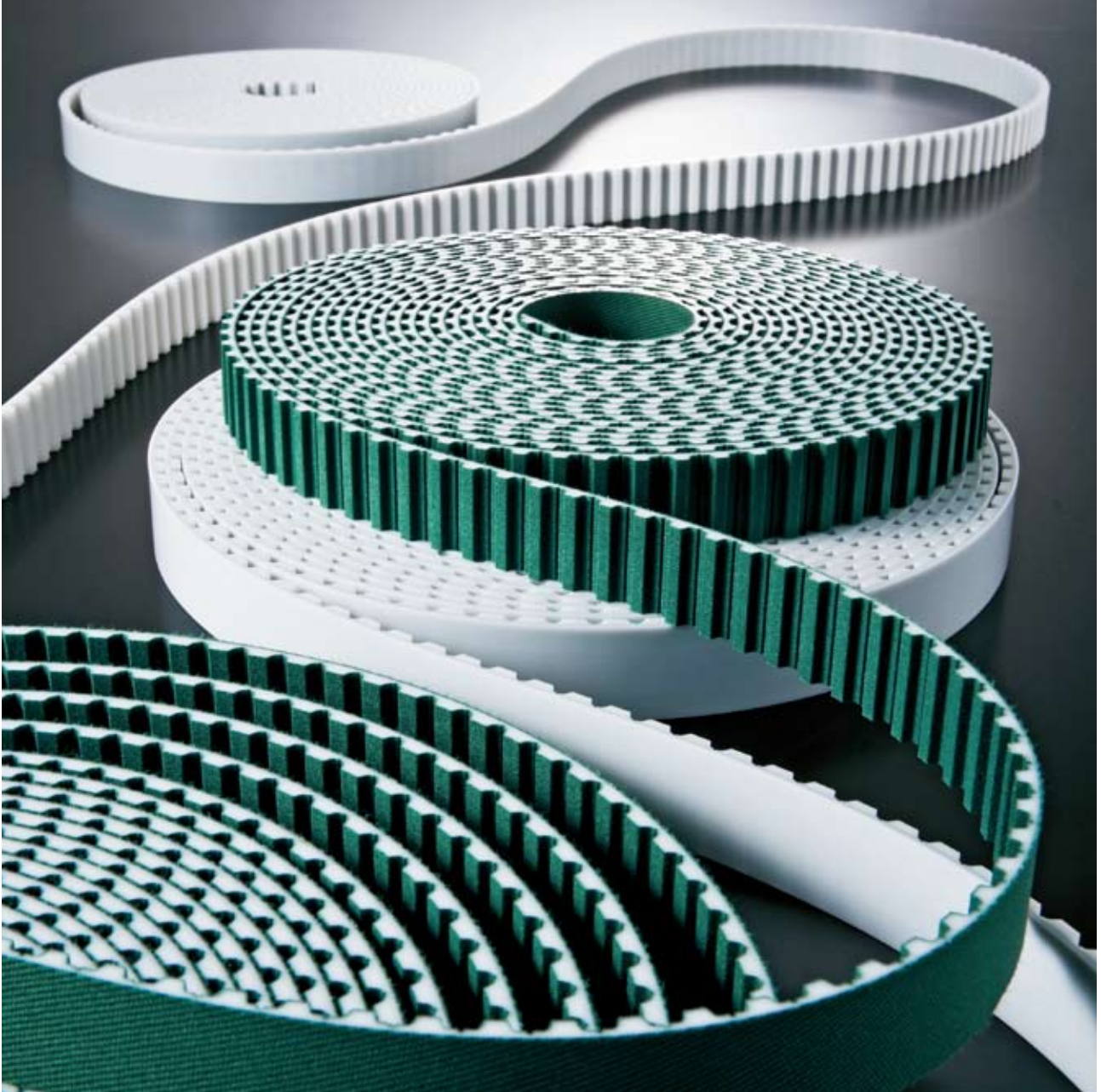

Polyurethane Timing Belt

FREESPAN™ Belt



PROVEN RELIABILITY



Table of Contents

Introduction

Structure, Mechanical / Material Characteristics 3

Standard Belt Type and Belt Order Code

Standard Line up, Belt Order Code 4

Applications

Open End Applications 5

Cleats Belt Applications 6

Vertical Conveyer

Level Conveyer Synchronous State

Design Manual

Design Conditions7

Design Procedure8

Linear Motion Design Procedure (Example)9

Calculation Parameters 10

Belt Tooth Profile Selection

Safety Factor, Coefficient of Friction 11

Tooth Profile

T5 12 AT5 14 HTD 5M 16

T10 13 AT10 15 HTD 8M 17



HTD 14M 18

Profile (Cleats) 19

Safety Precautions Please read all the warnings!

● Please take all necessary precautions when using our products. Also, Please review relevant product catalog and design documents, etc.

Significances of safety precautions are categorized as follows:

Signs	Meanings
 Danger	Imminently causing death or severe injury to the user who misuses products.
 Warning	Possibly causing death or severe injury to the user who misuses products.
 Caution	Possibly causing personal injury or property damage if misused.

Use

-  **Danger**
- If you expect that a belt will fail and idle, free-run, or stop the system, thus causing a fatal or severe accident, please provide an extra safety device.
 - Do not use a belt as a lifting or towing tool.

-  **Caution**
- Do not use a belt as an insulator. Contact us for information on insulation properties, which vary in belt type.

Function & Performance

-  **Caution**
- Do not use a belt beyond its capacity or for an application other than that specified by the catalog, design documents, etc. This can cause premature failure of the belt.
 - If water, oil, chemical, paint, dust, etc. sticks to a belt or pulley, its power transmission could deteriorate and the belt may fail.
 - A toothed belt makes louder noise during high-speed rotation. If this occurs, use a soundproof cover.

Storage & Transportation

-  **Warning**
- To store a heavy belt, use a suitable jig or stopper to prevent accidents such as belt toppling or tumbling.

-  **Caution**
- Use suitable equipment to carry/handle a heavy belt or pulley. Otherwise, back injury may result.
 - Do not put weight on or bend a belt forcibly to carry or store it. Otherwise, it will produce defects or scratches to the belt, resulting in damage.
 - Store the belt in low humidity and a temperature range of -10°C to 40°C. Do not expose belts to direct sunlight.

Mounting & Operation

-  **Danger**
- Install a safety cover over rotating components including belt/ pulley. Otherwise, hair, gloves and clothing can become entangled in the belt/pulley. If a belt/pulley breaks, fragments may cause injuries.
 - Take the following precautions to maintain, inspect and replace a belt.
 - 1) Turn off power and wait until the belt and pulley have stopped completely.
 - 2) Secure machinery so that it may not move during belt removal.
 - 3) Use caution : Do not unintentionally turn on power.

-  **Caution**
- Use the same type of belts or pulleys per OEM specification. Use of a different type may cause premature failure.
 - Misalignment of the pulleys can damage the belt and result in flange failure. Make proper adjustments to system.
 - Loosen the belt tension when changing belts. Do not force or stretch a belt over the flange. Do not use a screw driver or other sharp objects into when replacing the belt as this will result in damage.
 - Apply the appropriate belt tension as specified by the relevant catalog and design documents, etc. Inappropriate tension could result in damage of the belt and shaft.

Handling of Used items

-  **Caution**
- Do not burn belt, or hazardous gas could be produced.

Introduction

FREESPAN™ Belt is polyurethane timing belt made by MITSUBOSHI Belting Ltd.

FREESPAN™ Belt consists of thermoplastic polyurethane and steel cords.

This belt is suitable for synchronous transportation and power transmission requiring accurate positioning.

The tension members are parallel to each other to ensure a suitable synchronous drive. Polyurethane also has good physical properties & good chemical resistance.

Belt Temperature range is from -30°C to +80°C.

Structure

Polyurethane: ShoreA 92 Thermoplastic Polyurethane

Tension member: Zinc coated steel cords

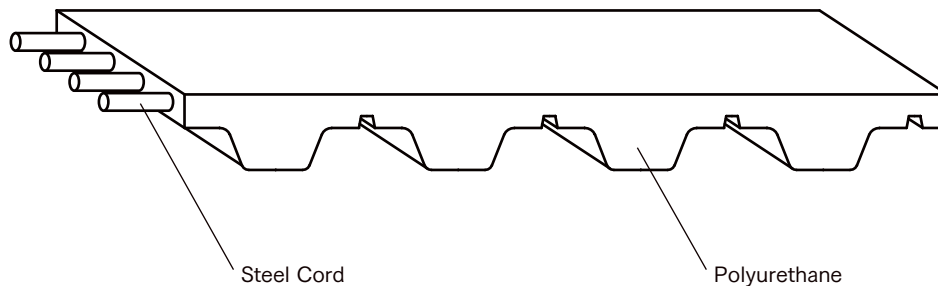

Table-1

Mechanical Characteristics

- High Flexibility
- Length Stability
- Low Friction

Material Characteristics

- Good Hydrolysis resistance
- Good Oil and Fuel resistance
- Good Abrasion resistance
- Good Weather resistance

		Chemicals	Resistance
Water	Water		○
	Salt Water		○
Acid	Acetic Acid		△
	Hydrochloric Acid 20%		△
	Sulfuric Acid 25%		△
	Nitric Acid		×
Alkalis	Ammonia 10%		○
	Sodium Hydroxide		△
Solvent	Kerosene		○
	Acetone		△
	Ethanol		△
	Isopropanol		△
	Methyl Ethyl Ketone		△
	Gasoline		△
	Methylene Chloride		×
	Toluene		×
Oil	Mineral Oil		○
	Diesel Oil		○
Grease	Lubricating Grease		○

○ : Good
 △ : Limited
 × : Poor

Standard Belt Type and Belt Order Code

Standard Line up

Table-2

Tooth Profile	Cord	Belt Type	Fabric Type	Max. Width
T5	Steel	Open-End, Joined	Tooth, Back, Tooth & Back	150mm
T10	Steel	Open-End, Joined	Tooth, Back, Tooth & Back	150mm
AT5	Steel	Open-End, Joined	Tooth, Back, Tooth & Back	150mm
AT10	Steel	Open-End, Joined	Tooth, Back, Tooth & Back	150mm
HTD 5M	Steel	Open-End, Joined	ASK	150mm
HTD 8M	Steel	Open-End, Joined	ASK	150mm
HTD 14M	Steel	Open-End, Joined	ASK	115mm

Belt Order Code

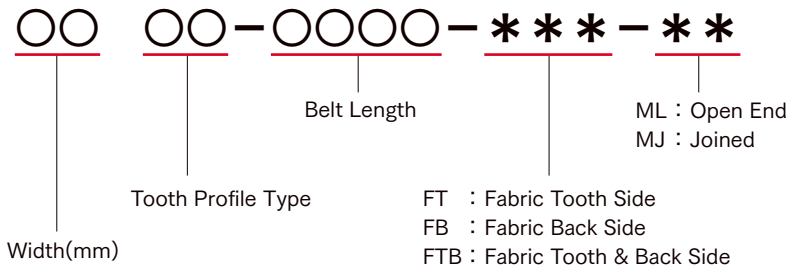

Example

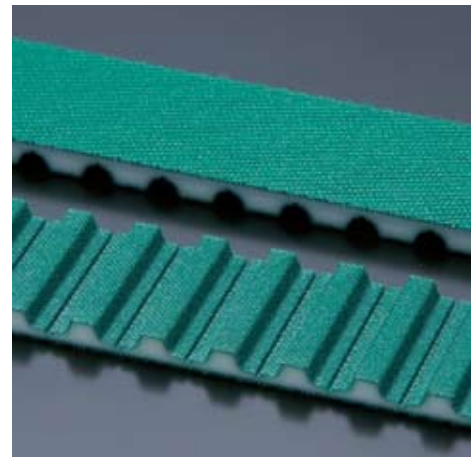
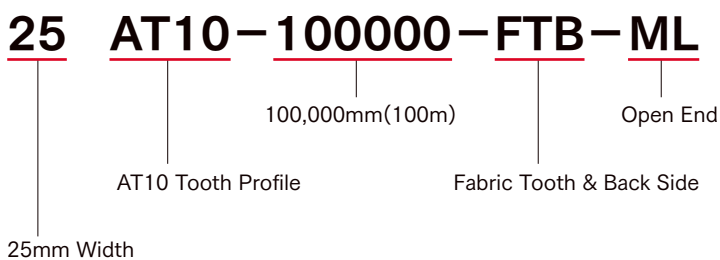
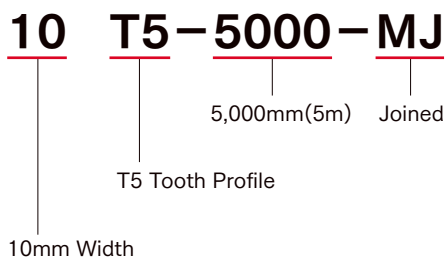

Available in any length (Up to 100m)

Applications

Open End Applications

- Linear Guide Positioning System
- Robot for Material Handling
- Automatic Door System (Elevators etc.)
- Lifting Machines
- Conveyers of Glass Plates for Displays (TV)
- Embroidery Machines
- Assembly Line for the Automotive Industry

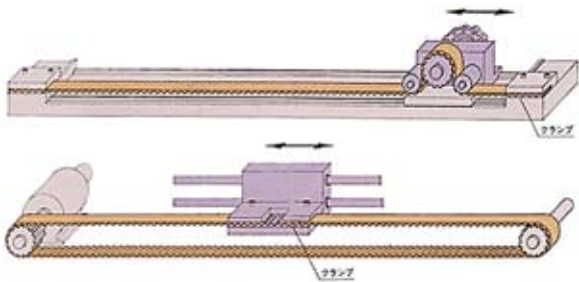

● X·Y·Z drive

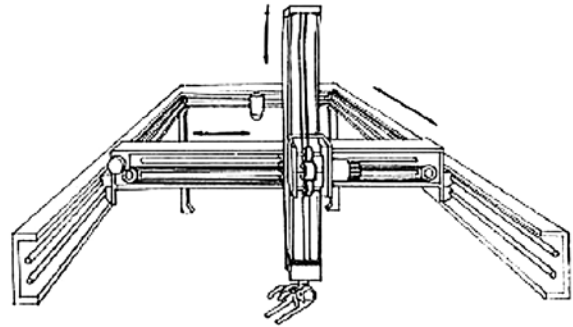

Large Industrial Robot



Embroidery Machine



Cleats Belt Applications

Packaging and Transfer System

Vertical Conveyor

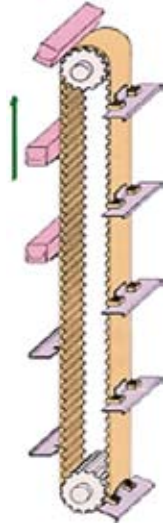

Level Conveyor Synchronous State

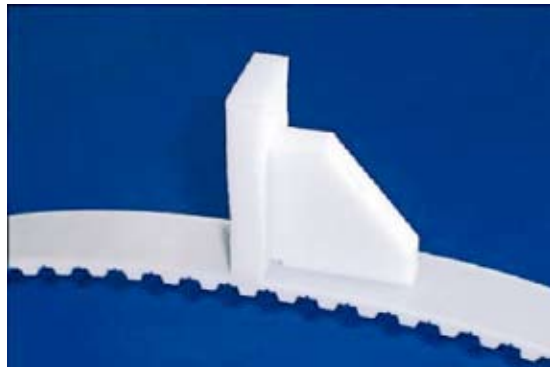
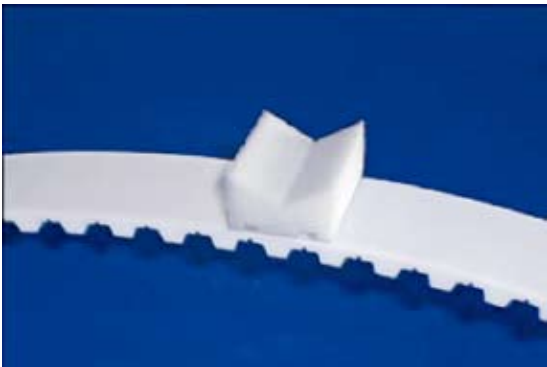
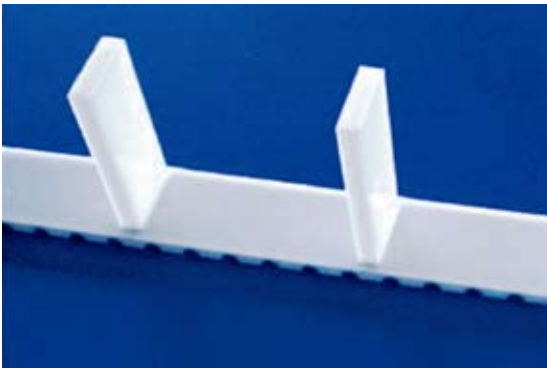
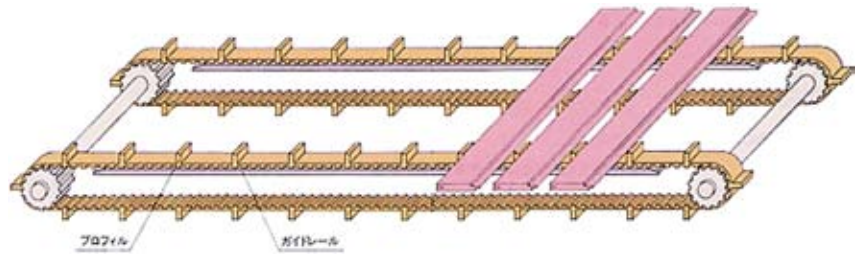

Design Manual

Design Conditions

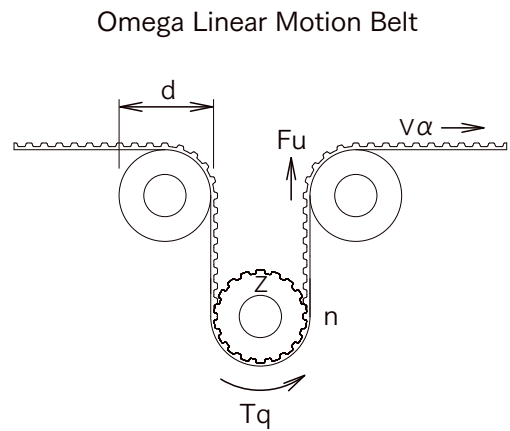
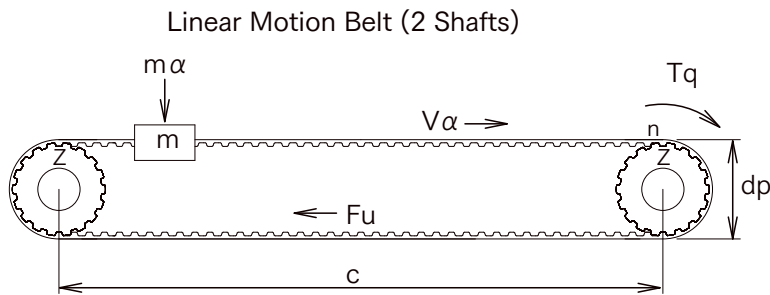

Definition

Table-3

	Definition	Unit
α	Acceleration	m/s ²
Bw	Belt Width	mm
Ks	Safety Factor	-
Zm	Meshing Tooth Number	-
d	Idler Pulley Diameter	mm
dp	Pulley Pitch Diameter	mm
Fp	Pretension	N
Fu	Peripheral Force	N
Fp spec	Tooth Share Strength	n/cm
ATL	Max Allowable Tensile Load	N
BS	Belt Breaking Strength	N
C	Center Distance	mm
g	Gravity	m/s ²
μ	Coefficient of Friction	-
m	Carriage Mass	kg
Tq	Drive Torque	Nm
n	Rpm of Pulley	1/min
Pr	Drive Power	kW
FR	Friction Force	N
V	Belt Speed	m/s
Zd	Pulley Groove Number	-

Useful Formulas

$$V = \frac{\pi \times dp \times n}{1000 \times 60} = \frac{dp \times n}{19100}$$

$$n = \frac{V \times 19100}{dp}$$

$$dp = \frac{V \times 19100}{n}$$

$$Tq = \frac{Fu \times dp}{2000}$$

$$Pr = \frac{Tq \times n}{9550}$$

$$Tq = \frac{9550 \times Pr}{n}$$

Design Procedure

STEP 1 Choice of Belt Tooth Profile

According to the Fig.-1, Select the tooth profile.
This figure is based on more than 12 teeth meshing.

STEP 2 Calculation of the Peripheral Force

In case of known Mass	Horizontal or Conveying	$F_u = (m \times \alpha) + (m \times g \times \mu)$
	Vertical	$F_u = (m \times \alpha) + (m \times g)$

Note: μ number is shown in Table-5

In case of known drive power

$$F_u = \frac{19.1 \times 1000000 \times Pr}{dp \times n}$$

In case of known drive torque

$$F_u = 2000Tq/dp$$

STEP 3 Determination of the Belt Width

The belt width is calculated by following formula.

$$Bw = (F_u \times K_s \times 10) / (F_{spec} \times Z_m)$$

F_u	Use above calculation result.
K_s	Safety factor
Z_m	Number of tooth meshing in drive pulley.
Z_m	$Z \times \text{arc of contact} / 360^\circ$
F_{spec}	Tooth share strength (N/cm)

STEP 4 Calculation of the Pre-Tension

Linear & Omega linear motion	$F_p = 2F_u$
Conveying	$F_p = F_u$

STEP 5 Checking the Allowable Tension

Ensure the maximum

Maximum allowable tension of the chosen belt $> F_p/2 + (F_u \times K_s)$

STEP 6 Pulley Diameter and Idler Pulley Diameter check

Pulley & Idler pulleys are equal to or bigger than the minimum pulley diameter.

STEP 7 Elongation

$$\Delta l = F_u / \text{Max allowable tension} \times (4/1000)$$

Linear Motion Design Procedure (Example)

Machine Condition

Center Distance	1000mm
Pulley Diameter	75mm
RPM	300rpm
Motor Power	1.5kW
Fluctuating Rate	Low → 1.4

STEP 1 Choice of Belt Tooth Profile

According to the belt profile selection table, We can choose AT10
Because Pulley diameter is 76mm, so $Z=24$ (O.D=74.54)

STEP 2 Calculation of the Peripheral Force

$$F_u = \frac{19.1 \times 1000000 \times P_r}{d_p \times n} = \frac{19.1 \times 1000000 \times 1.5}{300 \times 76.39} = 1,250N$$

STEP 3 Determination of the Belt Width

$$B_w = (F_u \times K_s \times 10) / (F_{spec} \times Z_m)$$

$B_w = \frac{F_u \times K_s \times 10}{F_{spec} \times Z_m}$	F_u	Use above calculation result
	K_s	Safety factor
	Z_m	Number of tooth meshing in drive pulley
$B_w = \frac{1250 \times 1.4 \times 10}{62 \times 12} = 23.5mm$	Z_m	$Z \times \text{arc of contact} / 360^\circ$
	F_{spec}	Tooth share strength (N/cm)

So, the next closest width is 25mm → 25AT10 is selected.

STEP 4 Calculation of the Pre-Tension

$$F_p = 2 \times F_u = 2 \times 1250 = 2500N$$

STEP 5 Checking the Allowable Tension

25AT10 Maximum allowable tension is 3610N

$$\text{Maximum allowable tension} > F_p/2 + (F_u \times K_s) = 1250N + 1250N \times 1.4 = 3000N$$

STEP 6 Pulley Diameter and Idler Pulley Diameter check

Pulley & Idler pulleys are equal to, or bigger than the minimum pulley diameter.

$$Z_d = 24 > Z_{min} = 14$$

STEP 7 Elongation

$$\begin{aligned} \Delta l &= F_u / \text{Max allowable tension} \times (4/1000) \\ &= 1250N / 3610N \times (4/1000) = 1.38mm/1000mm \end{aligned}$$

Calculation Parameters

Belt Tooth Profile Selection

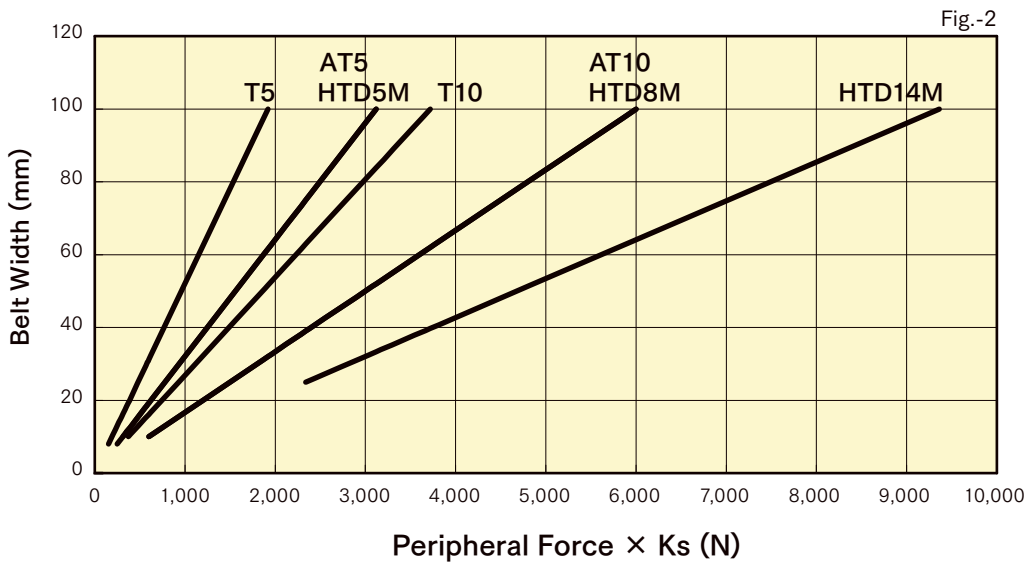
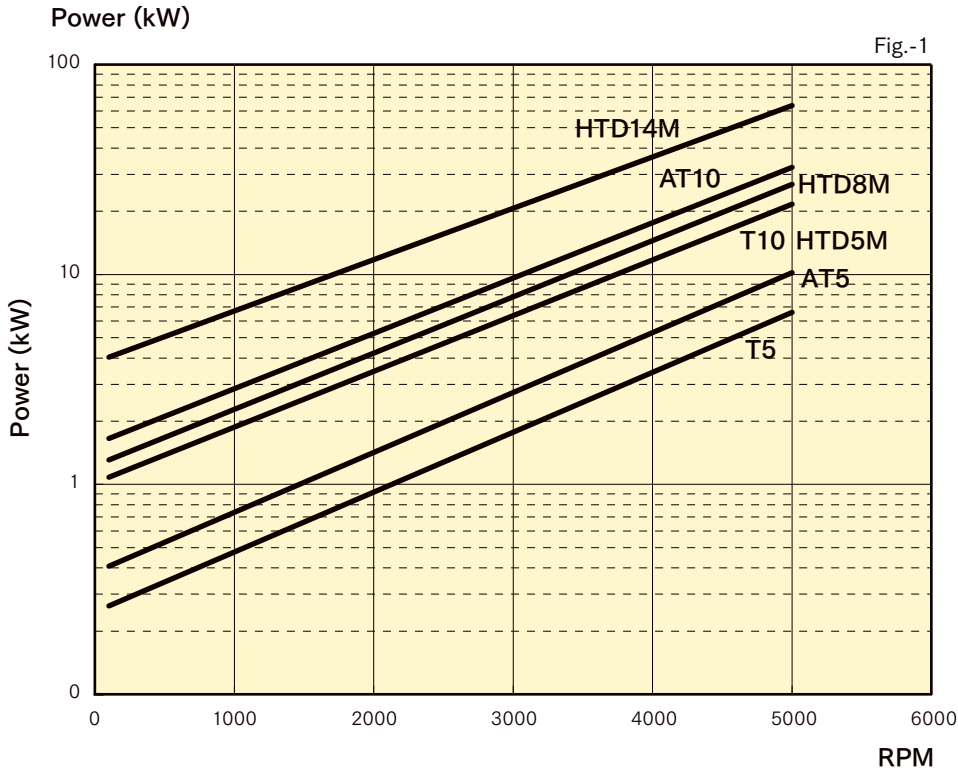

This graph gives a indication of the belt width for each tooth profile. Please calculate the belt width followed by calculation procedure.

*Graph condition is 1000rpm.

Safety Factor

Safety factor depends on the operating conditions,
Please use the following safety factor.

Table-4

Operating Condition		Safety Factor
Steady Load		1.0
Shock Load	Low	1.4
	Middle	1.7
	High	2.0

Coefficient of Friction

When the supporting table is used,
Please use the following Coefficient of Friction.

Table-5

	Polyurethane
Steel	0.7
Stainless	0.7
Aluminium	0.4
UHMW	0.3
Teflon	0.2

Tooth Profile

FREESPAN™ T5

Open End Belt
Joined Belt

Belt Characteristics

- Standard Color : White
- Polyurethane : Thermoplastic Polyurethane Shore A 92
- Standard Cords : S and Z zincked steel cords
- Standard Thickness : 2.2mm
- Standard Roll Length : 100m
- Belt Options : Joined Belt
Cleats
Fabric Type(FT, FB, FTB)

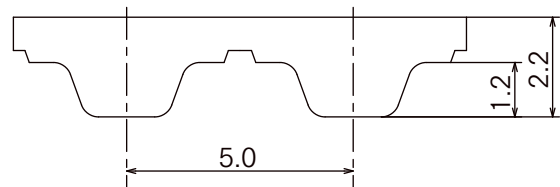

Belt Standard Width and Weight

Width(mm)	8	10	16	25	32	50	75	100	150
Weight(g/m)	18	22	35	55	70	110	165	220	330

Tooth Share Strength

rpm	0	20	40	60	80	100	200	300	400	500	750	1000	1500	2000	3000	4000	5000	8000
Fp spec(N/cm)	24	23	23	22	22	22	20	19	19	18	17	16	15	14	12	11	11	9

Max Allowable Tension

Width(mm)	8	10	16	25	32	50	75	100	150
Max Allowable Tensile Load	278	324	556	834	1112	1667	2501	3335	5002
Breaking Strength	1170	1365	2340	3510	4680	7020	10530	14040	21060

Pulley

Minimum Pulley

	T5	
2 Shafts	φ 18.27	12 Teeth
Ω Layout	φ 27.82	18 Teeth
Inside Idler	φ 30	—
Outside Idler	φ 30	—

Joined Belt

Minimum length : 1000mm

Tooth Share Strength and Max allowable Tension become 50%
Joined belt is suitable for transportation.

How to order

25 T5 - 100000 - * * * - * *

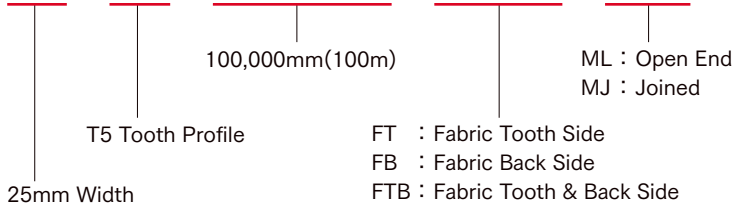

FREESPAN™ T10

Open End Belt
Joined Belt

Belt Characteristics

- Standard Color : White
- Polyurethane : Thermoplastic Polyurethane Shore A 92
- Standard Cords : S and Z zincked steel cords
- Standard Thickness : 4.5mm
- Standard Roll Length : 100m
- Belt Options : Joined Belt
Cleats
Fabric Type(FT, FB, FTB)

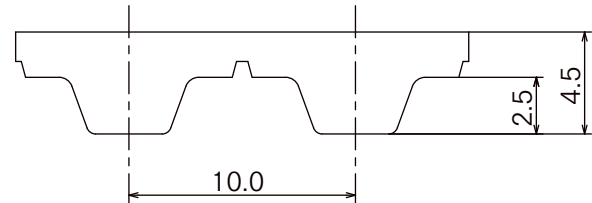

Belt Standard Width and Weight

Width(mm)	10	16	25	32	50	75	100	150
Weight(g/m)	45	72	113	144	225	338	450	675

Tooth Share Strength

rpm	0	20	40	60	80	100	200	300	400	500	750	1000	1500	2000	3000	4000	5000	8000
Fp spec(N/cm)	51	49	48	47	46	45	41	39	37	36	33	31	28	25	22	20	18	14

Max Allowable Tension

Width(mm)	10	16	25	32	50	75	100	150
Max Allowable Tensile Load	698	1097	1796	2195	3591	5387	7182	10773
Breaking Strength	2940	4620	7560	9240	15120	22680	30240	45360

Pulley

Minimum Pulley

	T10	
2 Shafts	φ 42.71	14 Teeth
Ω Layout	φ 61.81	20 Teeth
Inside Idler	φ 60	—
Outside Idler	φ 60	—

Joined Belt

Minimum length : 1000mm

Tooth Share Strength and Max allowable Tension become 50%
Joined belt is suitable for transportation.

How to order

25 T10-100000-*-****

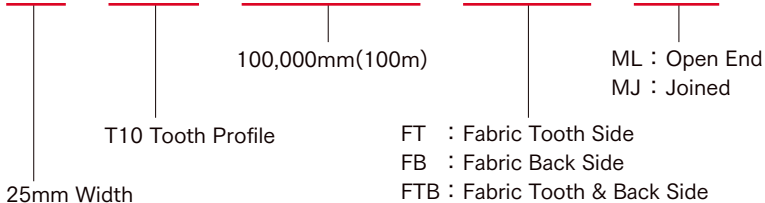

FREESPAN™ AT5

Open End Belt Joined Belt

Belt Characteristics

- Standard Color : White
- Polyurethane : Thermoplastic Polyurethane Shore A 92
- Standard Cords : S and Z zincked steel cords
- Standard Thickness : 2.7mm
- Standard Roll Length : 100m
- Belt Options : Joined Belt
Cleats
Fabric Type(FT, FB, FTB)

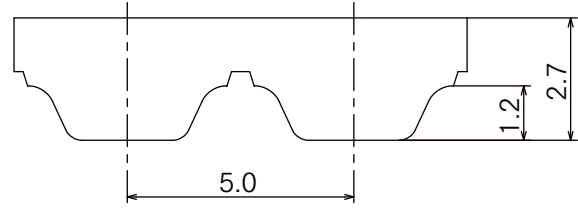

Belt Standard Width and Weight

Width(mm)	8	10	16	25	32	50	75	100	150
Weight(g/m)	26	33	53	83	106	165	248	330	495

Tooth Share Strength

rpm	0	20	40	60	80	100	200	300	400	500	750	1000	1500	2000	3000	4000	5000	8000
Fp spec(N/cm)	35	35	35	34	34	34	32	31	30	29	27	26	24	22	19	18	16	13

Max Allowable Tension

Width(mm)	8	10	16	25	32	50	75	100	150
Max Allowable Tensile Load	542	677	1083	1692	2166	3384	5077	6769	10153
Breaking Strength	2280	2850	4560	7125	9120	14250	21375	28500	42750

Pulley

Minimum Pulley

	AT5	
2 Shafts	φ 22.64	15 Teeth
Ω Layout	φ 38.56	25 Teeth
Inside Idler	φ 30	—
Outside Idler	φ 60	—

Joined Belt

Minimum length : 1000mm

Tooth Share Strength and Max allowable Tension become 50%

Joined belt is suitable for transportation.

How to order

25 AT5-100000-*-****

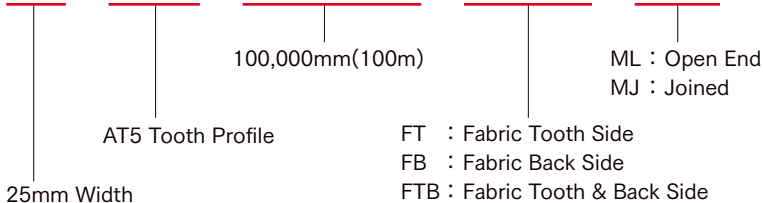

FREESPAN™ AT10

Open End Belt
Joined Belt

Belt Characteristics

- Standard Color : White
- Polyurethane : Thermoplastic Polyurethane Shore A 92
- Standard Cords : S and Z zincked steel cords
- Standard Thickness : 4.5mm
- Standard Roll Length : 100m
- Belt Options : Joined Belt
Cleats
Fabric Type(FT, FB, FTB)

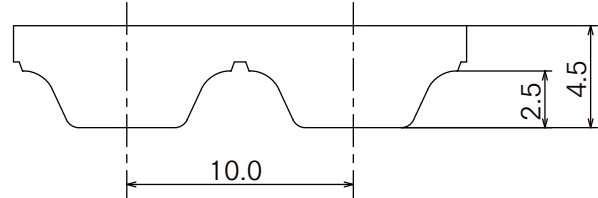

Belt Standard Width and Weight

Width(mm)	10	16	25	32	50	75	100	150
Weight(g/m)	60	96	150	192	300	450	600	900

Tooth Share Strength

rpm	0	20	40	60	80	100	200	300	400	500	750	1000	1500	2000	3000	4000	5000	8000
Fp spec(N/cm)	74	72	71	71	70	69	65	62	60	58	53	50	44	40	35	30	27	20

Max Allowable Tension

Width(mm)	10	16	25	32	50	75	100	150
Max Allowable Tensile Load	1354	2256	3610	4513	7220	10830	14440	21660
Breaking Strength	5700	9500	15200	19000	30400	45600	60800	91200

Pulley

Minimum Pulley

	AT10	
2 Shafts	φ 45.90	15 Teeth
Ω Layout	φ 77.73	25 Teeth
Inside Idler	φ 50	—
Outside Idler	φ 120	—

Joined Belt

Minimum length : 1000mm

Tooth Share Strength and Max allowable Tension become 50%
Joined belt is suitable for transportation.

How to order

25 AT10-100000-*-****

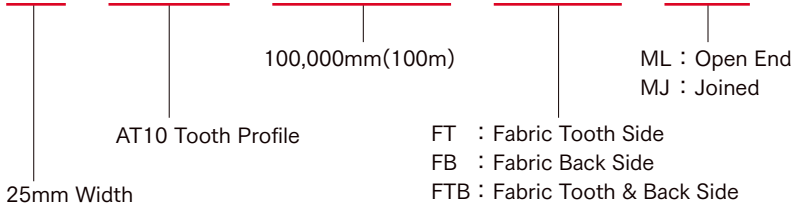

FREESPAN™ HTD 5M

Open End Belt
Joined Belt

Belt Characteristics

- Standard Color : White
- Polyurethane : Thermoplastic Polyurethane Shore A 92
- Standard Cords : S and Z zincked steel cords
- Standard Thickness : 3.6mm
- Standard Roll Length : 100m
- Belt Options : Joined Belt
Cleats

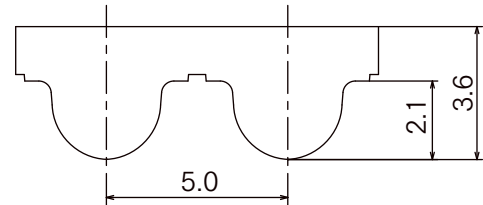

Belt Standard Width and Weight

Width(mm)	10	15	25	50	75	100	150
Weight(g/m)	41	62	103	205	308	410	615

Tooth Share Strength

rpm	0	20	40	60	80	100	200	300	400	500	1000	1500	2000	3000	4000	5000	8000
Fp spec(N/cm)	37	36	36	35	35	34	33	31	30	29	26	24	22	19	17	16	12

Max Allowable Tension

Width(mm)	10	15	25	50	75	100	150
Max Allowable Tensile Load	1031	1620	2651	5301	7952	10602	15903
Breaking Strength	4340	6820	11160	22320	33480	44640	66960

Pulley

Minimum Pulley

	HTD 5M	
2 Shafts	φ 22.28	14 Teeth
Ω Layout	φ 30.23	20 Teeth
Inside Idler	φ 50	—
Outside Idler	φ 50	—

Joined Belt

Minimum length : 1000mm

Tooth Share Strength and Max allowable Tension become 50%

Joined belt is suitable for transportation.

How to order

25 HTD 5M – 100000 – * *

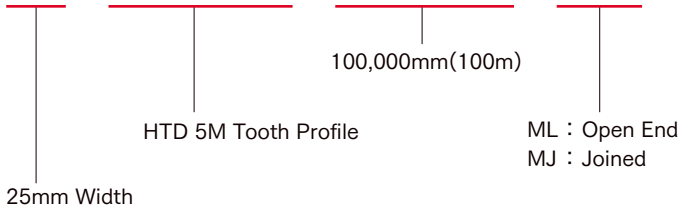

FREESPAN™ HTD 8M

Open End Belt
Joined Belt

Belt Characteristics

- Standard Color : White
- Polyurethane : Thermoplastic Polyurethane Shore A 92
- Standard Cords : S and Z zincked steel cords
- Standard Thickness : 5.6mm
- Standard Roll Length : 100m
- Belt Options : Joined Belt
Cleats

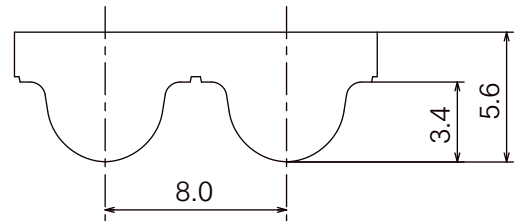

Belt Standard Width and Weight

Width(mm)	10	15	20	30	50	85	100	150
Weight(g/m)	59	89	118	177	295	502	590	885

Tooth Share Strength

rpm	0	20	40	60	80	100	200	300	400	500	1000	1500	2000	3000	4000	5000
Fp spec(N/cm)	74	72	71	70	69	68	64	62	59	57	48	43	39	33	28	25

Max Allowable Tension

Width(mm)	10	15	20	30	50	85	100	150
Max Allowable Tensile Load	1354	2256	2708	4513	7220	12184	14440	21660
Breaking Strength	5700	9500	11400	19000	30400	51300	60800	91200

Pulley

Minimum Pulley

	HTD 8M	
2 Shafts	φ 50.93	20 Teeth
Ω Layout	φ 76.39	30 Teeth
Inside Idler	φ 50	—
Outside Idler	φ 120	—

Joined Belt

Minimum length : 1000mm

Tooth Share Strength and Max allowable Tension become 50%
Joined belt is suitable for transportation.

How to order

20 HTD 8M – 100000 – * *

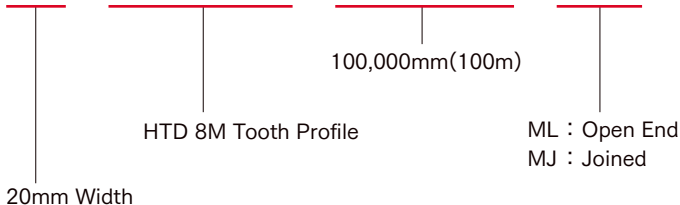

FREESPAN™ HTD 14M

Open End Belt
Joined Belt

Belt Characteristics

- Standard Color : White
- Polyurethane : Thermoplastic Polyurethane Shore A 92
- Standard Cords : S and Z zincked steel cords
- Standard Thickness : 10.0mm
- Standard Roll Length : 50m
- Belt Options : Joined Belt
Cleats

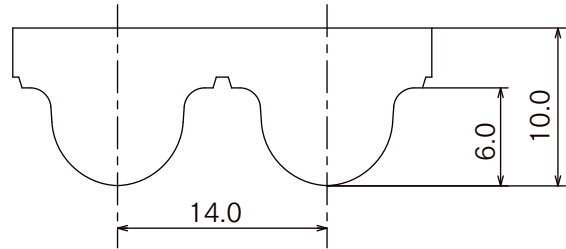

Belt Standard Width and Weight

Width(mm)	25	40	55	85	100	115
Weight(g/m)	268	428	589	910	1,070	1,231

Tooth Share Strength

rpm	0	20	40	60	80	100	200	300	400	500	1000	1500	2000	3000	4000
Fp spec(N/cm)	130	128	126	123	122	120	110	104	99	95	78	67	59	47	38

Max Allowable Tension

Width(mm)	25	40	55	85	100	115
Max Allowable Tensile Load	5752	9039	12326	18900	23009	26296
Breaking Strength	24220	38060	51900	79580	96880	110720

Pulley

Minimum Pulley

	HTD 14M	
2 Shafts	φ 124.77	28 Teeth
Ω Layout	φ 124.77	28 Teeth
Inside Idler	φ 120	—
Outside Idler	φ 180	—

Joined Belt

Minimum length : 1000mm

Tooth Share Strength and Max allowable Tension become 50%
Joined belt is suitable for transportation.

How to order

25 HTD 14M – 100000 – * *

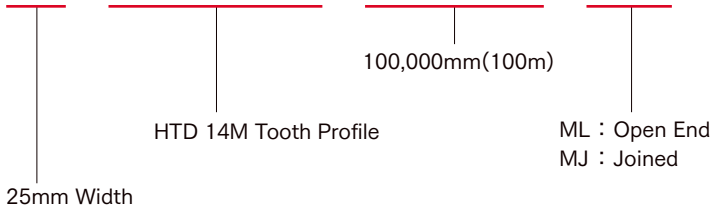

Profile (Cleats)

Freespan belt can be welded variously shaped Cleats on the Belt.

Cleats Material

Thermoplastic Polyurethane Shore A 92

Standard Rectangle Cleats

Thickness of cleats is available from 2mm to 10mm

Height of the cleats is available from 20mm to 50mm

Position of the Cleats

We recommend that Cleats should be mounted over the tooth position.

This position gives the better flexibility.

Cleats over the tooth position

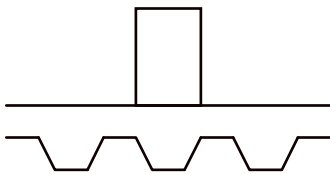

Cleats not over the tooth

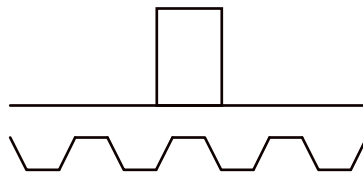

Tolerance of the Cleats

Cleats thickness Tolerance		$\pm 0.5\text{mm}$
Cleats Height Tolerance		$\pm 0.5\text{mm}$
Tolerance of the position		$\pm 0.5\text{mm}$
P: Cleats Pitch Tolerance	$\leq 250\text{mm}$	$\pm 0.5\text{mm}$
	$250\text{mm} < \leq 500\text{mm}$	$\pm 1.0\text{mm}$
	$500\text{mm} <$	$\pm 2.0\text{mm}$

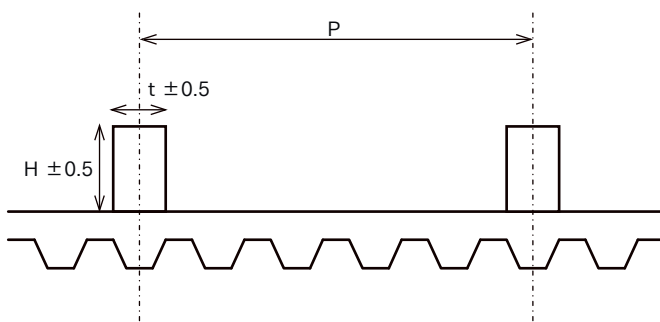

Burr at welded Cleats

When the cleats are welded on the belt, The Burr tend to occurs at root of the Cleats.

If this burr interfere the function, please request us to remove the burr.

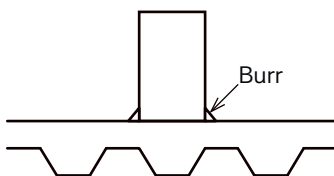

Molded Cleats

We can produce the special cleats as follows.

If you need special cleats, please contact us.

